

Pendant

INSTRUCTION MANUAL

Safety Warnings

- This product is only suitable for connection to a 220-240V~50Hz supply in accordance with current IEE wiring regulations, and should be installed in accordance with local building regulations. It is for domestic ceiling use only, and is not suitable for a bathroom location.
- Before installing your light fitting always switch off the mains supply and remove the appropriate fuse or switch off the appropriate circuit breaker before commencing installation.
- This is a Class II product and **must NOT** be connected to Earth. The terminal blocks are supplied according to requirements of the fitting.
- Never fit bulbs of a higher wattage than those specified on the label as these may damage the fitting).
- If you are in any doubt about your competence please consult a qualified electrician.
- **This product contains very delicate parts** – be careful during handling and maintenance to avoid breakage. Spare glass balls are available - please contact your retailer or call our service team on 0333 00 333 08.
- If any modification is made it will invalidate the warranty and may render the product unsafe.

Care Information

Allow 10 minutes to cool before replacing, adjusting or cleaning.
Clean with a dry cloth only. Do not use liquid or abrasive cleaners on this product.

Assembly/ User Instructions

Before you start

Please read these instructions carefully before fitting and retain for reference. Check the packaging and make sure that you have all the required parts. Follow each assembly step in order to prevent incorrect assembly. Ensure that the product is fully assembled as illustrated before use.

The light pack contains:

Light fitting. 5 x Spare Clips
Terminal connection block(s). 33x glass balls
Fixing pack.
1x Frame (E)

The following tools may be required:

Selection of cross and flat head screwdrivers.
Electric drill and assorted drill bits.
Wire strippers.





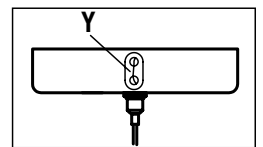
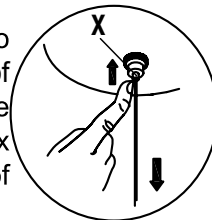

These assembly diagrams are intended as a guide – if in doubt consult a qualified electrician.

1. Decide on the position of the light fitting or remove existing light fitting. Note the position of the electrical connections, and ensure there is a solid mounting surface, preferably a wooden joist or joist bridge, to support the weight of the light fitting.
2. If you want to reduce the overall length of the fitting, this will be easier to complete before attaching the product to the ceiling. To reduce the drop of this pendant, push the steel cable up into the ceiling cover. To increase the drop press button X. To reduce the length of the electrical flex, pull the flex through the cable grip Y in the ceiling cover. Always ensure the weight of the product is supported by the steel cable and not the electrical flex.
3. Remove the two side screws and retain for re-use. Use the fixing bracket (A) as a template to mark the screw holes. Make the screw holes and secure to the ceiling with appropriate screw fixings (B&C).
4. Support your fitting and connect the house wiring to the terminal block – see expanded wiring details below.
NOTE: This is a Class II fitting and must NOT be earthed.
5. Secure the ceiling cup over the bracket by using the screws removed in Point 3.
6. Attach frame E (1) over the lower hooks on light fitting (D).
7. Fit the bulbs (2). **NOTE: Never fit bulbs of a higher wattage than those specified on the label, as these may cause overheating and damage the fitting.**



Assembly/ User Instructions Continued

8. Fit the glass balls (F). Starting from the lowest point of the fitting, hook the glass balls onto the frame working around and upwards so the glass hangs correctly. To attach, locate the clip at the top of the balls through the metal rings around the frame. Be careful not to let the glass balls collide as damage could occur.
9. Turn on the power and test.

NO	A	B	C	D	E	F
						
Qty	1	2	2	1	1	33

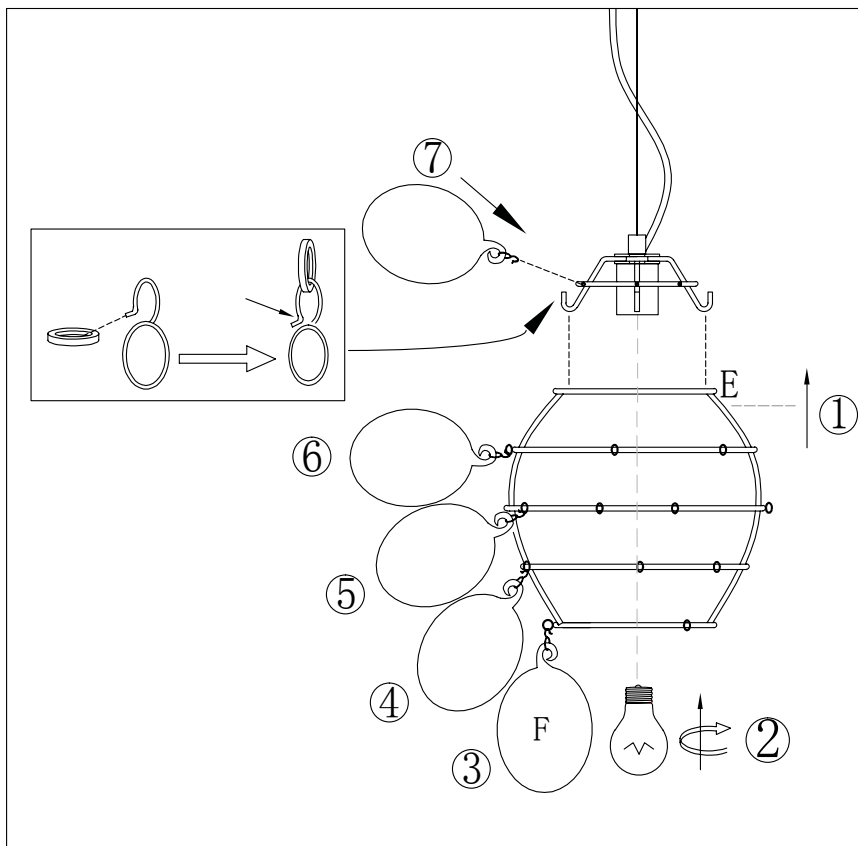
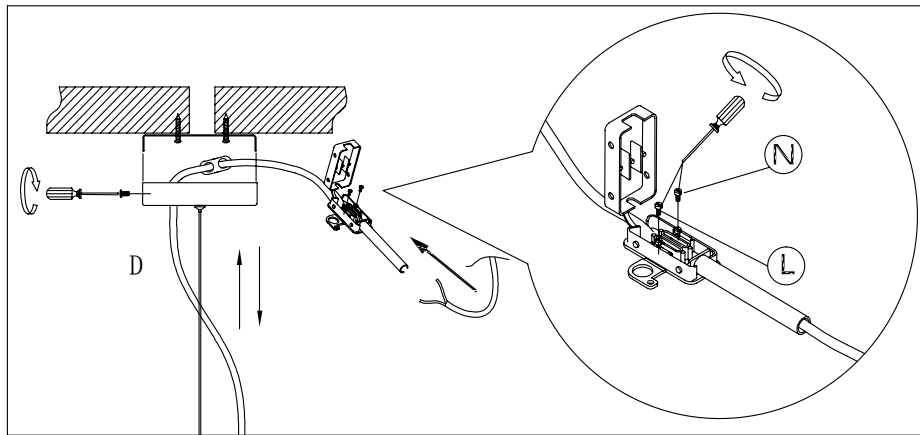
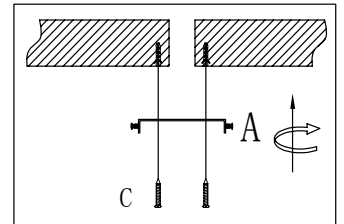
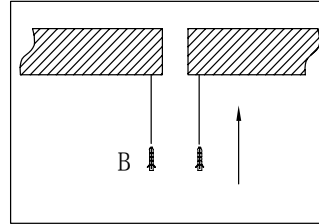

- EN Scan QR code for multi-language
- FR Scannez le code QR pour plusieurs langues
- ES Escanee el código QR para varios idiomas
- PL Zeskanuj kod QR dla wielu języków
- DE Scannen Sie den QR-Code nach mehreren Sprachen
- IT Scansiona il codice QR per multilingua



UK Manufacturer: BH17 7BY
 EU Manufacturer: Brilliant AG,
 Brilliantstrasse 1, D-27442 Gnarrenburg